

LED-PROFILE

LED PROFILES

LED-Profil Serie Convex

LED profile series Convex

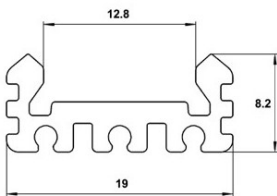

036404 Convex 2 m, silber eloxiert
Convex 2 m, silver anodized



035548 Endkappe grau, mit Zugentlastung
End cap grey, with cord strain relief



035549 Endkappe grau, ohne Loch
End cap grey, without hole



035547 Zugentlaster-Mutter
Cord strain relief nut



035545 Schrauben für Endkappen
Screws for end caps



031200 Abdeckung 2 m, klar, rastend
Cover 2 m, clear, snap-in



035462 Abdeckung 2 m, opal, rastend
Cover 2 m, opal, snap-in



031406 Halteklammern
Bracket

LED-Profil Serie Chase

LED profile series Chase

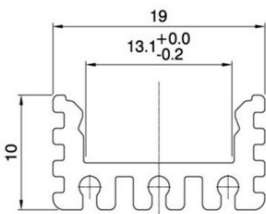

035783 Chase Low 2 m, silber eloxiert
Chase Low 2 m, silver anodized



035726 Endkappe grau, mit Loch
End cap grey, with hole



035727 Endkappe grau, ohne Loch
End cap grey, without hole



035545 Schrauben für Endkappen
Screws for end caps



035787 Abdeckung 2 m, klar, rastend
Cover 2 m, clear, snap-in



035788 Abdeckung 2 m, opal, rastend
Cover 2 m, opal, snap-in



031406 Halteklammern
Bracket

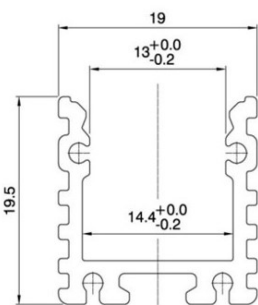

035784 Chase High 2 m, silber eloxiert
Chase High 2 m, silver anodized



035728 Endkappe grau, mit Zugentlastung
End cap grey, with cord strain relief



035729 Endkappe grau, ohne Loch
End cap grey, without hole



035730 Zugentlaster
Cord strain relief



035547 Zugentlaster-Mutter
Cord strain relief nut



035545 Schrauben für Endkappen
Screws for end caps



035787 Abdeckung 2 m, klar, rastend
Cover 2 m, clear, snap-in



035788 Abdeckung 2 m, opal, rastend
Cover 2 m, opal, snap-in



031406 Halteklammern
Bracket



035731 Halteplatte
Fixing plate

*Profile in silber eloxiert sind lagernd, alle anderen Farben auf Anfrage

*Profiles in silver anodized are on stock, all other colours are on demand

LED-Profil Serie Wing

LED profile series Wing

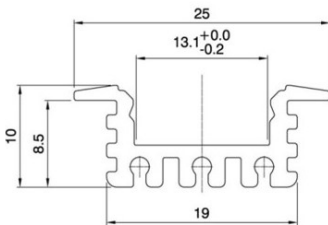

035782 Wing Low 2 m, silber eloxiert
Wing Low 2 m, silver anodized



035722 Endkappe grau, mit Loch
End cap grey, with hole



035723 Endkappe grau, ohne Loch
End cap grey, without hole



035545 Schrauben für Endkappen
Screws for end caps



035787 Abdeckung 2 m, klar, rastend
Cover 2 m, clear, snap-in



035788 Abdeckung 2 m, opal, rastend
Cover 2 m, opal, snap-in



031406 Halteklammern
Bracket

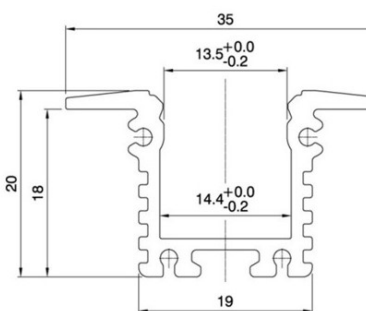

035785 Wing High 2 m, silber eloxiert
Wing High 2 m, silver anodized



035724 Endkappe grau, mit Loch
End cap grey, with hole



035725 Endkappe grau, ohne Loch
End cap grey, without hole



035545 Schrauben für Endkappen
Screws for end caps



035787 Abdeckung 2 m, klar, rastend
Cover 2 m, clear, snap-in



035788 Abdeckung 2 m, opal, rastend
Cover 2 m, opal, snap-in



031406 Halteklammern
Bracket



035731 Halteplatte
Fixing plate

LED-Profil Serie Basic

LED profile series Basic

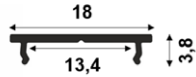
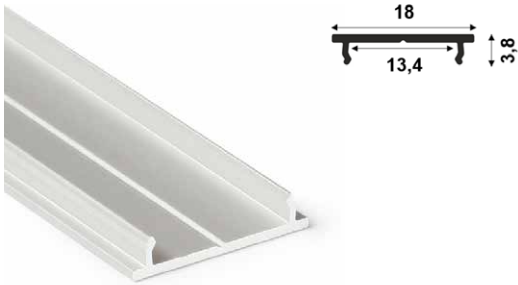

801010 Basic-S 2 m, silber eloxiert
Basic-S 2 m, silver anodized

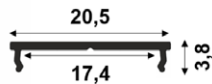
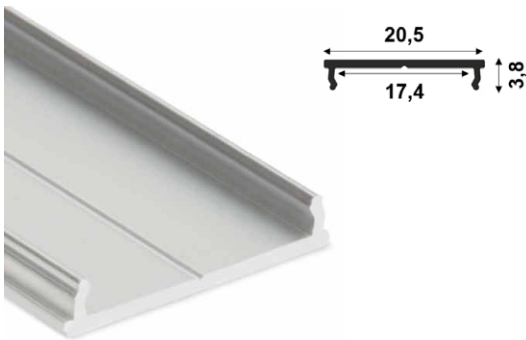

801010 Basic-S 2 m, silber eloxiert
Basic-S 2 m, silver anodized

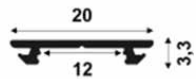
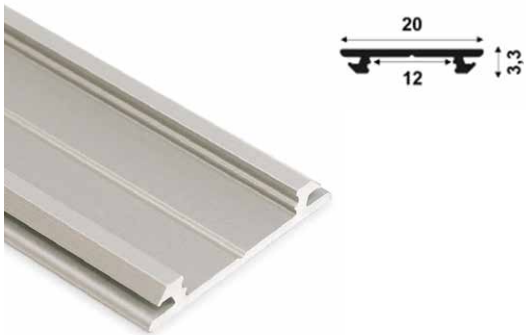

801020 Basic-Bow 2 m, silber eloxiert
Basic-Bow 2 m, silver anodized



801228 Satz Endkappen eckig, silber, ohne Loch
Set of end caps square, silver, without hole



801029 Satz Endkappen halbrund, silber, ohne Loch
Set of end caps half round, silver without hole



801305 Abdeckung 13 mm x 2 m, klar, rastend
Cover 13 mm x 2 m, clear, snap-in



801306 Abdeckung 13 mm x 2 m, opal, rastend
Cover 13 mm x 2 m, opal, snap-in



801326 Abdeckung 13 mm x 2 m, rauch, rastend
Cover 13 mm x 2 m, smoke, snap-in



801025 Abdeckung 19,5 mm x 2 m, opal, umgreifend
Cover 19,5 mm x 2 m, opal, clasping



801342 Satz Halteklammern 20 mm, glatt + Schrauben
Set of brackets 20 mm, flat + screws



801343 Satz Halteklammern 20 mm, gewinkelt + Schrauben
Set of brackets 20 mm, angulated + screws

LED-Profil Serie Universal

LED profile series Universal

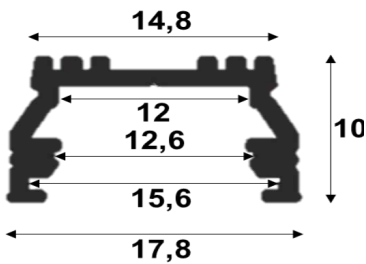

801305 Abdeckung 13 mm x 2 m, klar, rastend
Cover 13 mm x 2 m, clear, snap-in



801306 Abdeckung 13 mm x 2 m, opal, rastend
Cover 13 mm x 2 m, opal, snap-in



801326 Abdeckung 13 mm x 2 m, rauch, rastend
Cover 13 mm x 2 m, smoke, snap-in



801311 Abdeckung 15 mm x 2 m, klar, einschiebbar
Cover 15 mm x 2 m, clear, slideable



801312 Abdeckung 15 mm x 2 m, matt, einschiebbar
Cover 15 mm x 2 m, frosted, slideable



801313 Abdeckung 15 mm x 2 m, opal, einschiebbar
Cover 15 mm x 2 m, opal, slideable



801025 Abdeckung 19,5 mm x 2 m, opal, umgreifend
Cover 19,5 mm x 2 m, opal, clasp



801331 Satz Halteklammern 14 mm, glatt + Schrauben
Set of brackets 14 mm, flat + screws



801334 Satz Halteklammern 14 mm, konisch + Schrauben
Set of brackets 14 mm, cone + screws

*Profile in silber eloxiert sind lagernd, alle anderen Farben auf Anfrage
*Profiles in silver anodized are on stock, all other colours are on demand



801380 Universal 2 m, silber eloxiert
Universal 2 m, silver anodized



801381* Universal 2 m, Aluminium unbehandelt
Universal 2 m, aluminium raw



801382* Universal 2 m, weiß lackiert
Universal 2 m, white painted



801383* Universal 2 m, schwarz eloxiert
Universal 2 m, black anodized



801386 Satz Endkappen grau, mit Loch
Set of end caps grey, with hole



801387 Satz Endkappen grau, ohne Loch
Set of end caps grey, without hole



801388 Satz Endkappen silber, mit Loch
Set of end caps silver, with hole



801389 Satz Endkappen silber, ohne Loch
Set of end caps silver, without hole



801390 Satz Endkappen schwarz, mit Loch
Set of end caps black, with hole



801391 Satz Endkappen schwarz, ohne Loch
Set of end caps black, without hole



801392 Satz Endkappen weiß, mit Loch
Set of end caps white, with hole



801393 Satz Endkappen weiß, ohne Loch
Set of end caps white, without hole



801396 Satz Endkappen grau, mit Loch
Set of end caps grey, with hole



801397 Satz Endkappen grau, ohne Loch
Set of end caps grey, without hole



801398 Satz Endkappen silber, mit Loch
Set of end caps silver, with hole



801399 Satz Endkappen silber, ohne Loch
Set of end caps silver, without hole



801401 Satz Endkappen schwarz, ohne Loch
Set of end caps black, without hole



801402 Satz Endkappen weiß, mit Loch
Set of end caps white, with hole



801403 Satz Endkappen weiß, ohne Loch
Set of end caps white, without hole

LED-Profil Serie Cube-S

LED profile series Cube-S

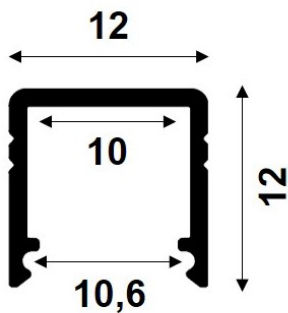

801260 Cube-S 2 m, silber eloxiert
Cube-S 2 m, silver anodized



801261* Cube-S 2 m, Aluminium unbehandelt
Cube-S 2 m, aluminium raw



801262* Cube-S 2 m, weiß lackiert
Cube-S 2 m, white painted



801263* Cube-S 2 m, schwarz eloxiert
Cube-S 2 m, black anodized



801266 Satz Endkappen grau, mit Loch
Set of end caps grey, with hole



801267 Satz Endkappen grau, ohne Loch
Set of end caps grey, without hole



801268 Satz Endkappen silber, mit Loch
Set of end caps silver, with hole



801269 Satz Endkappen silber, ohne Loch
Set of end caps silver, without hole



801270 Satz Endkappen schwarz, mit Loch
Set of end caps black, with hole



801271 Satz Endkappen schwarz, ohne Loch
Set of end caps black, without hole



801272 Satz Endkappen weiß, mit Loch
Set of end caps white, with hole



801273 Satz Endkappen weiß, ohne Loch
Set of end caps white, without hole



801300 Abdeckung 10 mm x 2 m, klar, einschiebbar
Cover 10 mm x 2 m, clear, slideable



801301 Abdeckung 10 mm x 2 m, matt, einschiebbar
Cover 10 mm x 2 m, opal, slideable



801302 Abdeckung 10 mm x 2 m, opal, einschiebbar
Cover 10 mm x 2 m, opal, slideable



801330 Satz Halteklammern 12 mm, glatt + Schrauben
Set of brackets 12 mm, flat + screws



801333 Satz Halteklammern 12 mm, konisch + Schrauben
Set of brackets 12 mm, cone + screws

*Profile in silber eloxiert sind lagernd, alle anderen Farben auf Anfrage

*Profiles in silver anodized are on stock, all other colours are on demand

LED-Profil Serie Cube-M

LED profile series Cube-M

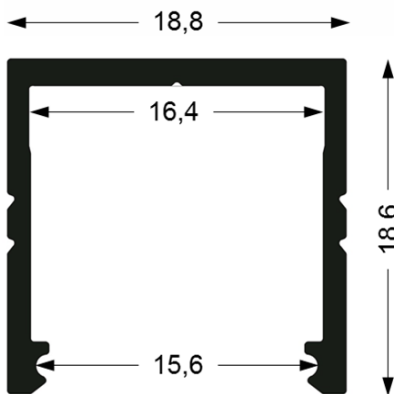

*Profile in silber eloxiert sind lagernd, alle anderen Farben auf Anfrage

*Profiles in silver anodized are on stock, all other colours are on demand



801480 Cube-M 2 m, silber eloxiert
Cube-M 2 m, silver anodized



801481* Cube-M 2 m, Aluminium unbehandelt
Cube-M 2 m, aluminium raw



801482* Cube-M 2 m, weiß lackiert
Cube-M 2 m, white painted



801483* Cube-M 2 m, schwarz eloxiert
Cube-M 2 m, black anodized



801487 Satz Endkappen grau, ohne Loch
Set of end caps grey, without hole



801489 Satz Endkappen silber, ohne Loch
Set of end caps silver, without hole



801491 Satz Endkappen schwarz, ohne Loch
Set of end caps black, without hole



801493 Satz Endkappen weiß, ohne Loch
Set of end caps white, without hole



801309 Abdeckung 15 mm x 2 m, klar, rastend
Cover 15 mm x 2 m, clear, snap-in



801310 Abdeckung 15 mm x 2 m, opal, rastend
Cover 15 mm x 2 m, opal, snap-in



801328 Abdeckung 15 mm x 2 m, rauch, rastend
Cover 15 mm x 2 m, smoke, snap-in



801311 Abdeckung 15 mm x 2 m, klar, einschiebbar
Cover 15 mm x 2 m, clear, slideable



801312 Abdeckung 15 mm x 2 m, matt, einschiebbar
Cover 15 mm x 2 m, frosted, slideable



801313 Abdeckung 15 mm x 2 m, opal, einschiebbar
Cover 15 mm x 2 m, opal, slideable



801350 Satz Halteklammern 19,5 mm, glatt + Schrauben
Set of brackets 19,5 mm, flat + screws



801351 Satz Halteklammern 19,5 mm, konisch + Schrauben
Set of brackets 19,5 mm, cone + screws

LED-Profil Serie Cube-L

LED profile series Cube-L

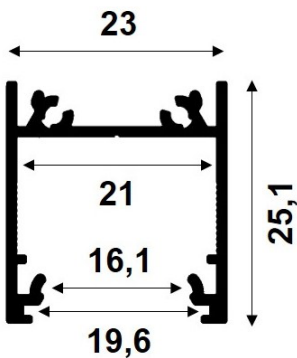

801332 Satz Halteklammern 18 mm, glatt + Schrauben
Set of brackets 18 mm, flat + screws



801335 Satz Halteklammern 18 mm, konisch + Schrauben
Set of brackets 18 mm, cone + screws



801340 Satz Halteplatten 18 mm, glatt + Schrauben
Set of mounting plates 18 mm, flat + screws



801341 Verbindungsplatte 18 x 50 mm, glatt + Schrauben
Connector plate 18 x 50 mm, flat + screws



801346 Seilabhangung silber, SELV 50V, 1,5 m, 20N
Wire suspension silver, SELV 50V, 1,5 m, 20N



801347 Seilabhangung chrom, 1,5 m, 100N
Wire suspension chrome, 1,5 m, 100N



801360 Cube-L 2 m, silber eloxiert
Cube-L 2 m, silver anodized



801361* Cube-L 2 m, Aluminium unbehandelt
Cube-L 2 m, aluminium raw



801362* Cube-L 2 m, wei lackiert
Cube-L 2 m, white painted



801363* Cube-L 2 m, schwarz eloxiert
Cube-L 2 m, black anodized



801367 Satz Endkappen grau, mit Loch
Set of end caps grey, with hole



801369 Satz Endkappen silber, ohne Loch
Set of end caps silver, without hole



801371 Satz Endkappen schwarz, mit Loch
Set of end caps black, with hole



801373 Satz Endkappen wei, ohne Loch
Set of end caps white, without hole



801379 Cube-L, Blende 2 m, silber eloxiert
Cube-L, cover 2 m, silver anodized



801314 Abdeckung 17 mm x 2 m, klar, rastend
Cover 17 mm x 2 m, clear, snap-in



801315 Abdeckung 17 mm x 2 m, opal, rastend
Cover 17 mm x 2 m, opal, snap-in



801316 Abdeckung 19 mm x 2 m, klar, einschiebbar
Cover 19 mm x 2 m, clear, slideable



801317 Abdeckung 19 mm x 2 m, matt, einschiebbar
Cover 19 mm x 2m, frosted, slideable



801318 Abdeckung 19 mm x 2 m, opal, einschiebbar
Cover 19 mm x 2m, opal, slideable

*Profile in silber eloxiert sind lagernd, alle anderen Farben auf Anfrage
*Profiles in silver anodized are on stock, all other colours are on demand

LED-Profil Serie Cube-Multi

LED profil series Cube-Multi

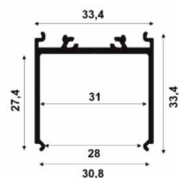
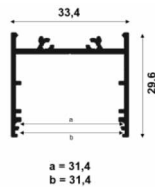
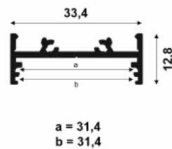

801332 Satz Halteklammern 14 mm, glatt + Schrauben
Set of brackets 14 mm, flat + screws



801335 Satz Halteklammern 14 mm, konisch + Schrauben
Set of brackets 14 mm, cone + screws



801340 Satz Halteplatten 14 mm, glatt + Schrauben
Set of mounting plates 14 mm, flat + screws



801341 Verbindungsplatte 14 x 50 mm, glatt + Schrauben
Connector plate 14 x 50 mm, flat + screws



801346 Seilabhängung Silber, SELV 50 V, 1,5 m, 20 N
Wire suspension silver, SELV 50 V, 1.5 m, 20 N



801347 Seilabhängung Chrom, 1,5 m, 100 N
Wire suspension chrome, 1.5 m, 100 N



801050 Cube-Multi Flat 2 m, silber eloxiert
Cube-Multi Flat 2 m, silver anodized



801051 Cube-Multi High 2 m, silber eloxiert
Cube-Multi High 2 m, silver anodized



801052 Cube-Multi Side 2 m, silber eloxiert
Cube-Multi Side 2 m, silver anodized



801053 Cube-Multi Case 2 m, silber eloxiert
Cube-Multi Case 2 m, silver anodized



801070 Satz Endkappen Flat silber, ohne Loch
Set of end caps Flat silver, without hole



801071 Satz Endkappen High silber, ohne Loch
Set of end caps High silver, without hole



801072 Satz Endkappen Side silber, ohne Loch
Set of end caps Side silver, without hole



801073 Satz Endkappen Case silber, ohne Loch
Set of end caps Case silver, without hole



801056 Cube-Multi Blende 2 m, silber eloxiert
Cube-Multi cover 2 m, silver anodized



801057 Cube-Multi Blende 2 m, silber eloxiert
Cube-Multi cover 2 m, silver anodized



801090 Abdeckung Quader 30 mm x 2 m, opal, rastend
Cover cuboid 30 mm x 2 m, opal, snap-in



801091 Satz Endkappen Quader opal, ohne Loch
Set of end caps cuboid opal, without hole



801092 Abdeckung halbrund 30 mm x 2 m, opal, rastend
Cover half round 30 mm x 2 m, opal, snap-in



801093 Satz Endkappen halbrund opal, ohne Loch
Set of end caps half round opal, without hole



801094 Abdeckung 30 mm x 2 m, klar, rastend
Cover 30 mm x 2 m, clear, snap-in



801095 Abdeckung 30 mm x 2 m, opal, rastend
Cover 30 mm x 2 m, opal, snap-in



801096 Abdeckung 31 mm x 2 m, klar, einschiebbar
Cover 31 mm x 2 m, clear, slideable



801097 Abdeckung 31 mm x 2 m, matt, einschiebbar
Cover 31 mm x 2 m, frosted, slideable









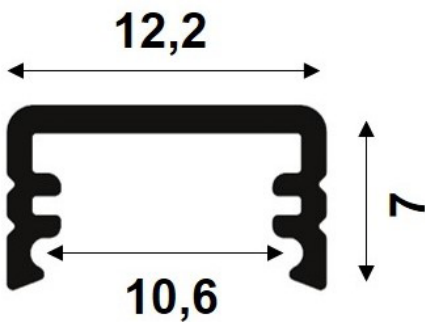









801098 Abdeckung 31 mm x 2 m, opal, einschiebbar
Cover 31 mm x 2 m, opal, slideable

LED-Profil Serie Xtra-Small

LED profil series Xtra-Small



	801120	Xtra-Small 2 m, silber eloxiert <i>Xtra-Small 2 m, silver anodized</i>
	801121*	Xtra-Small 2 m, Aluminium unbehandelt <i>Xtra-Small 2 m, aluminium raw</i>
	801122*	Xtra-Small 2 m, weiß lackiert <i>Xtra-Small 2 m, white painted</i>
	801123*	Xtra-Small 2 m, schwarz eloxiert <i>Xtra-Small 2 m, black anodized</i>
	801126	Satz Endkappen grau, mit Loch <i>Set of end caps grey, with hole</i>
	801127	Satz Endkappen grau, ohne Loch <i>Set of end caps grey, without hole</i>
	801128	Satz Endkappen silber, mit Loch <i>Set of end caps silver, with hole</i>
	801129	Satz Endkappen silber, ohne Loch <i>Set of end caps silver, without hole</i>
	801130	Satz Endkappen schwarz, mit Loch <i>Set of end caps black, with hole</i>
	801131	Satz Endkappen schwarz, ohne Loch <i>Set of end caps black, without hole</i>
	801132	Satz Endkappen weiß, mit Loch <i>Set of end caps white, with hole</i>
	801133	Satz Endkappen weiß, ohne Loch <i>Set of end caps white, without hole</i>
	801300	Abdeckung 10 x 2 m, klar, einschiebbar <i>Cover 10 x 2 m, clear, slideable</i>
	801301	Abdeckung 10 x 2 m, matt, einschiebbar <i>Cover 10 x 2 m, frosted, slideable</i>
	801302	Abdeckung 10 x 2 m, opal, einschiebbar <i>Cover 10 x 2 m, opal, slideable</i>
	801330	Satz Halteklammern 12 mm, glatt + Schrauben <i>Set of brackets 12 mm, flat + screws</i>
	801333	Satz Halteklammern 12 mm, konisch + Schrauben <i>Set of brackets 12 mm, cone + screws</i>

*Profile in silber eloxiert sind lagernd, alle anderen Farben auf Anfrage
*Profiles in silver anodized are on stock, all other colours are on demand

LED-Profil Serie Xtra-M

LED profile series Xtra-M

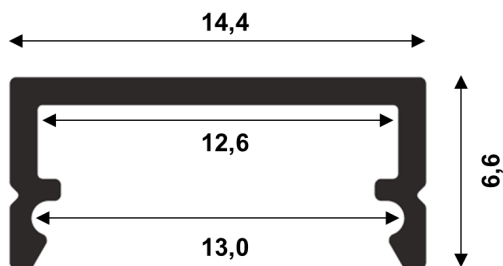
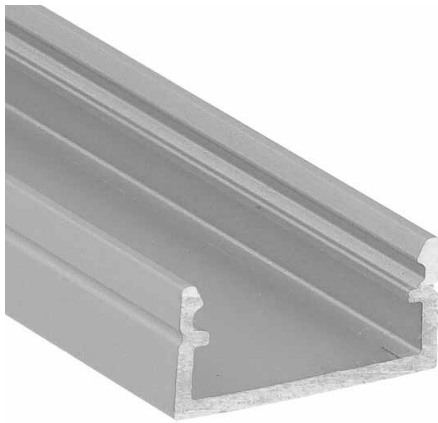

801325 Abdeckung 13 mm x 2 m, opal, slideable
Cover 13 mm x 2 m, opal, slideable



801344 Satz Halteklammern 15 mm, glatt + Schrauben
Set of brackets 15 mm, flat + screws



801345 Satz Halteklammern 15 mm, konisch + Schrauben
Set of brackets 15 mm, cone + screws



801460 Xtra-M 2 m, silber eloxiert
Xtra-M 2 m, silver anodized



801461* Xtra-M 2 m, Aluminium unbehandelt
Xtra-M 2 m, aluminium raw



801462* Xtra-M 2 m, weiß lackiert
Xtra-M 2 m, white painted



801463* Xtra-M 2 m, schwarz eloxiert
Xtra-M 2 m, black anodized



801466** Satz Endkappen grau, ohne Loch, flach
Set of end caps grey, without hole, flat



801467** Satz Endkappen grau, ohne Loch, hoch
Set of end caps grey, without hole, high



801468** Satz Endkappen silber, ohne Loch, flach
Set of end caps silver, without hole, flat



801469** Satz Endkappen silber, ohne Loch, hoch
Set of end caps silver, without hole, high



801470** Satz Endkappen schwarz, ohne Loch, flach
Set of end caps black, without hole, flat



801471** Satz Endkappen schwarz, ohne Loch, hoch
Set of end caps black, without hole, high



801472** Satz Endkappen weiß, ohne Loch, flach
Set of end caps white, without hole, flat



801473** Satz Endkappen weiß, ohne Loch, hoch
Set of end caps white, without hole, high



801305 Abdeckung 13 mm x 2 m, klar, rastend
Cover 13 mm x 2m, clear, snap-in



801306 Abdeckung 13 mm x 2 m, opal, rastend
Cover 13 mm x 2m, opal, snap-in



801326 Abdeckung 13 mm x 2 m, rauch, rastend
Cover 13 mm x 2m, smoke, snap-in



801323 Abdeckung 13 mm x 2 m, klar, einschiebbar
Cover 13 mm x 2 m, clear, slideable



801324 Abdeckung 13 mm x 2 m, matt, einschiebbar
Cover 13 mm x 2 m, frosted, slideable

*Profile in silber eloxiert sind lagernd, alle anderen Farben auf Anfrage
*Profiles in silver anodized are on stock, all other colours are on demand

** Flache Endkappen sind für einschiebbare Abdeckungen und hohe Endkappen für rastende Abdeckungen geeignet

** Flat end caps are suitable for slideable covers and high end caps are suitable for snap-in covers.

LED-Profil Serie Xtra-Flat-S

LED profil series Xtra-Flat-S

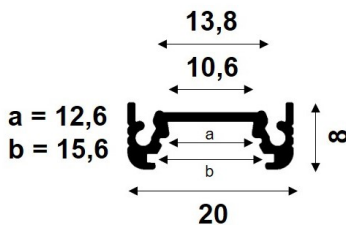

801311 Abdeckung 15 mm, 2 m, klar, einschiebbar
Cover 15 mm, 2 m, clear, slideable



801312 Abdeckung 15 mm, 2 m, matt, einschiebbar
Cover 15 mm, 2 m, frosted, slideable



801313 Abdeckung 15 mm, 2 m, opal, einschiebbar
Cover 15 mm, 2 m, opal, slideable



801331 Satz Halteklammern 14 mm, glatt + Schrauben
Set of brackets 14 mm, flat + screws



801334 Satz Halteklammern 14 mm, konisch + Schrauben
Set of brackets 14 mm, cone + screws



801338 Satz Halteplatten 14 mm, glatt + Schrauben
Set of mounting plates 14 mm, flat + screws



801339 Verbindungsplatte 14 x 50 mm, glatt + Schrauben
Connector plate 14 x 50 mm, flat + screws



801180 Xtra-Flat-S 2 m, silber eloxiert
Xtra-Flat-S 2 m, silver anodized



801181* Xtra-Flat-S 2 m, Aluminium unbehandelt
Xtra-Flat-S 2 m, aluminium raw



801182* Xtra-Flat-S 2 m, weiß lackiert
Xtra-Flat-S 2 m, white painted



801183* Xtra-Flat-S 2 m, schwarz eloxiert
Xtra-Flat-S 2 m, black anodized



801186 Satz Endkappen grau, mit Loch
Set of end caps grey, with hole



801187 Satz Endkappen grau, ohne Loch
Set of end caps grey, without hole



801188 Satz Endkappen silber, mit Loch
Set of end caps silver, with hole



801189 Satz Endkappen silber, ohne Loch
Set of end caps silver, without hole



801190 Satz Endkappen schwarz, mit Loch
Set of end caps black, with hole



801191 Satz Endkappen schwarz, ohne Loch
Set of end caps black, without hole



801192 Satz Endkappen weiß, mit Loch
Set of end caps white, with hole



801193 Satz Endkappen weiß, ohne Loch
Set of end caps white, without hole



801305 Abdeckung 13 mm x 2 m, klar, rastend
Cover 13 mm x 2 m, clear, snap-in



801306 Abdeckung 13 mm x 2 m, opal, rastend
Cover 13 mm x 2 m, opal, snap-in



801326 Abdeckung 13 mm x 2 m, rauch, rastend
Cover 13 mm x 2 m, smoke, snap-in





*Profile in silber eloxiert sind lagernd, alle anderen Farben auf Anfrage

*Profiles in silver anodized are on stock, all other colours are on demand

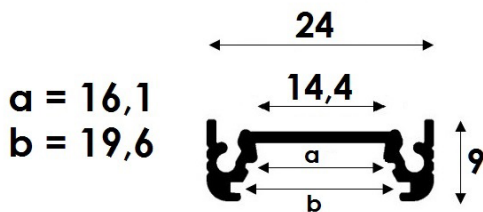
LED-Profil Serie Xtra-Flat-M

LED profile series Xtra-Flat-M



- 
801332 Satz Halteklammern 18 mm, glatt + Schrauben
Set of brackets 18 mm, flat + screws
- 
801335 Satz Halteklammern 18 mm, konisch + Schrauben
Set of brackets 18 mm, cone + screws
- 
801340 Satz Halteplatten 14 mm, glatt + Schrauben
Set of mounting plates 14 mm, flat + screws
- 
801341 Verbindungsplatte 18 x 50 mm, glatt + Schraube
Connector plate 18 x 50 mm, flat + screw

- 
801280 Xtra-Flat-M 2 m, silber eloxiert
Xtra-Flat-M 2 m, silver anodized
 - 
801281* Xtra-Flat-M 2 m, Aluminium unbehandelt
Xtra-Flat-M 2 m, aluminium raw
 - 
801282* Xtra-Flat-M 2 m, weiß lackiert
Xtra-Flat-M 2 m, white painted
 - 
801283* Xtra-Flat-M 2 m, schwarz eloxiert
Xtra-Flat-M 2 m, black anodized
-
- 
801286 Satz Endkappen grau, mit Loch
Set of end caps grey, with hole
 - 
801287 Satz Endkappen grau, ohne Loch
Set of end caps grey, without hole
 - 
801288 Satz Endkappen silber, mit Loch
Set of end caps silver, with hole
 - 
801289 Satz Endkappen silber, ohne Loch
Set of end caps silver, without hole
 - 
801290 Satz Endkappen schwarz, mit Loch
Set of end caps black, with hole
 - 
801291 Satz Endkappen schwarz, ohne Loch
Set of end caps black, without hole
 - 
801292 Satz Endkappen weiß, mit Loch
Set of end caps white, with hole
 - 
801293 Satz Endkappen weiß, ohne Loch
Set of end caps white, without hole
 - 
801314 Abdeckung 17 mm x 2 m, klar, rastend
Cover 17 mm x 2m, clear, snap-in
 - 
801315 Abdeckung 17 mm x 2 m, opal, rastend
Cover 17 mm x 2m, opal, snap-in
 - 
801327 Abdeckung 17 mm x 2 m, rauch, rastend
Cover 17 mm x 2m, smoke, snap-in
 - 
801316 Abdeckung 19 mm x 2 m, klar, einschiebbar
Cover 19 mm x 2 m, clear, slideable
 - 
801317 Abdeckung 19 mm x 2 m, matt, einschiebbar
Cover 19 mm x 2 m, frosted, slideable
 - 
801318 Abdeckung 19 mm x 2 m, opal, einschiebbar
Cover 19 mm x 2 m, opal, slideable

LED-Profil Serie Angle-S

LED profil series Angle-S

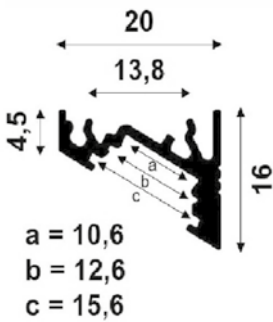

801311 Abdeckung 15 mm, 2 m, klar, einschiebbar
Cover 15 mm, 2 m, clear, slideable



801312 Abdeckung 15 mm, 2 m, matt, einschiebbar
Cover 15 mm, 2 m, frosted, slideable



801313 Abdeckung 15 mm, 2 m, opal, einschiebbar
Cover 15 mm, 2 m, opal, slideable



801331 Satz Halteklammern 14 mm, glatt + Schrauben
Set of brackets 14 mm, flat + screws



801334 Satz Halteklammern 14 mm, konisch + Schrauben
Set of brackets 14 mm, cone + screws



801338 Satz Halteplatten 14 mm, glatt + Schrauben
Set of mounting plates 14 mm, flat + screws



801339 Verbindungsplatte 14 x 50 mm, glatt + Schrauben
Connector plate 14 x 50 mm, flat + screws



801200 Angle-S 2 m, silber eloxiert
Angle-S 2 m, silver anodized



801201* Angle-S 2 m, Aluminium unbehandelt
Angle-S 2 m, aluminium raw



801202* Angle-S 2 m, weiß lackiert
Angle-S 2 m, white painted



801203* Angle-S 2 m, schwarz eloxiert
Angle-S 2 m, black anodized



801206 Satz Endkappen grau, mit Loch
Set of end caps grey, with hole



801207 Satz Endkappen grau, ohne Loch
Set of end caps grey, without hole



801208 Satz Endkappen silber, mit Loch
Set of end caps silver, with hole



801209 Satz Endkappen silber, ohne Loch
Set of end caps silver, without hole



801210 Satz Endkappen schwarz, mit Loch
Set of end caps black, with hole



801211 Satz Endkappen schwarz, ohne Loch
Set of end caps black, without hole



801212 Satz Endkappen weiß, mit Loch
Set of end caps white, with hole



801213 Satz Endkappen weiß, ohne Loch
Set of end caps white, without hole



801305 Abdeckung 13 mm x 2 m, klar, rastend
Cover 13 mm x 2 m, clear, snap-in



801306 Abdeckung 13 mm x 2 m, opal, rastend
Cover 13 mm x 2 m, opal, snap-in



801326 Abdeckung 13 mm x 2 m, rauch, rastend
Cover 13 mm x 2 m, smoke, snap-in

*Profile in silber eloxiert sind lagernd, alle anderen Farben auf Anfrage

*Profiles in silver anodized are on stock, all other colours are on demand

LED-Profil Serie Angle-M

LED profil series Angle-M

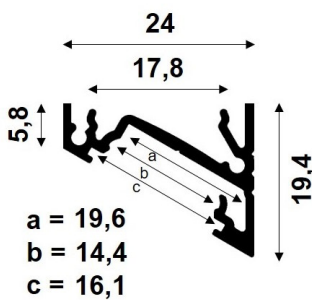

801332 Satz Halteklammern 18 mm, glatt + Schrauben

Set of brackets 18 mm, flat + screws



801335 Satz Halteklammern 18 mm, konisch + Schrauben

Set of brackets 18 mm, cone + screws



801340 Satz Halteplatten 18 mm, glatt + Schrauben

Set of mounting plates 18 mm, flat + screws



801341 Verbindungsplatte 14 x 50 mm, glatt + Schrauben

Connector plate 14 x 50 mm, flat + screws



801240 Angle-M 2 m, silber eloxiert
Angle-M 2 m, silver anodized



801241* Angle-M 2 m, Aluminium unbehandelt
Angle-M 2 m, aluminium raw



801242* Angle-M 2 m, weiß lackiert
Angle-M 2 m, white painted



801243* Angle-M 2 m, schwarz eloxiert
Angle-M 2 m, black anodized



801246 Satz Endkappen grau, mit Loch
Set of end caps grey, with hole



801247 Satz Endkappen grau, ohne Loch
Set of end caps grey, without hole



801248 Satz Endkappen silber, mit Loch
Set of end caps silver, with hole



801249 Satz Endkappen silber, ohne Loch
Set of end caps silver, without hole



801250 Satz Endkappen schwarz, mit Loch
Set of end caps black, with hole



801251 Satz Endkappen schwarz, ohne Loch
Set of end caps black, without hole



801252 Satz Endkappen weiß, mit Loch
Set of end caps white, with hole



801253 Satz Endkappen weiß, ohne Loch
Set of end caps white, without hole



801314 Abdeckung 17 mm x 2 m, klar, rastend
Cover 17 mm x 2 m, clear, snap-in



801315 Abdeckung 17 mm x 2 m, opal, rastend
Cover 17 mm x 2 m, opal, snap-in



801316 Abdeckung 19 mm x 2 m, klar, einschiebbar
Cover 19 mm x 2 m, clear, slideable



801317 Abdeckung 19 mm x 2 m, matt, einschiebbar
Lens cover 19 mm x 2 m, frosted, slideable



801318 Abdeckung 19 mm, 2 m, matt, einschiebbar
Cover 19 mm, 2 m, frosted, slideable

*Profile in silber eloxiert sind lagernd, alle anderen Farben auf Anfrage
*Profiles in silver anodized are on stock, all other colours are on demand

LED-Profil Serie Extended

LED profil series Extended

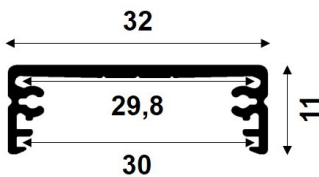
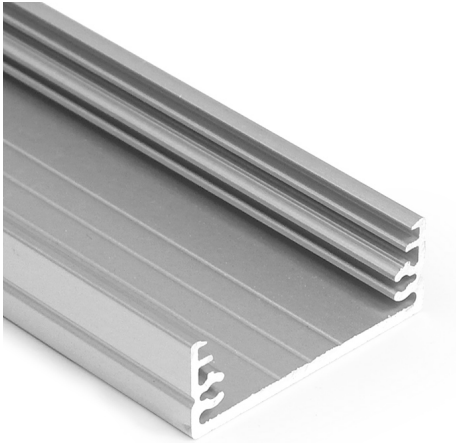

801140 Extended 2 m, silber eloxiert
Extended 2 m, silver anodized



801141* Extended 2 m, Aluminium unbehandelt
Extended 2 m, aluminium raw



801142* Extended 2 m, weiß lackiert
Extended 2 m, white painted



801143* Extended 2 m, schwarz eloxiert
Extended 2 m, black anodized



801146 Satz Endkappen grau, mit Loch
Set of end caps grey, with hole



801147 Satz Endkappen grau, ohne Loch
Set of end caps grey, without hole



801148 Satz Endkappen silber, mit Loch
Set of end caps silver, with hole



801149 Satz Endkappen silber, ohne Loch
Set of end caps silver, without hole



801150 Satz Endkappen schwarz, mit Loch
Set of end caps black, with hole



801151 Satz Endkappen schwarz, ohne Loch
Set of end caps black, without hole



801152 Satz Endkappen weiß, mit Loch
Set of end caps white, with hole



801153 Satz Endkappen weiß, ohne Loch
Set of end caps white, without hole



801320 Abdeckung 30 mm x 2 m, klar, einschiebbar
Cover 30 mm x 2 m, clear, slideable



801321 Abdeckung 30 mm x 2 m, matt, einschiebbar
Cover 10 x 2 m, frosted, slideable



801322 Abdeckung 30 mm x 2 m, opal, einschiebbar
Cover 30 mm x 2 m, opal, slideable



801336 Satz Halteklammern 32 mm, konisch + Schrauben
Set of brackets 32 mm, cone + screws

*Profile in silber eloxiert sind lagernd, alle anderen Farben auf Anfrage

*Profiles in silver anodized are on stock, all other colours are on demand

LED-Profil SerieTwinline

LED profil series Twinline

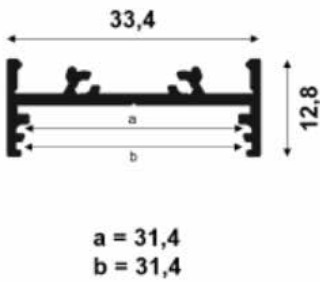

801300 Abdeckung 10 x 2 m, klar, einschiebbar
Cover 10 x 2m, clear, slideable



801301 Abdeckung 10 x 2 m, matt, einschiebbar
Cover 10 x 2m, frosted, slideable



801302 Abdeckung 10 x 2 m, opal, einschiebbar
Cover 10 x 2m, opal, slideable



801331 Satz Halteklammern 14 mm, glatt + Schrauben
Set of brackets 14 mm, flat + screws



801334 Satz Halteklammern 14 mm, konisch + Schrauben
Set of brackets 14 mm, cone + screws



801338 Satz Halteplatten 14 mm, glatt + Schrauben
Set of mounting plates 14 mm, flat + screws



801339 Verbindungsplatte 14 x 50 mm, glatt + Schraube
Connector plate 14 x 50 mm, flat + screws



801100 Twinline 2 m, silber eloxiert
Twinline 2 m, silver anodized



801101* Twinline 2 m, Aluminium unbehandelt
Twinline 2 m, aluminium raw



801102* Twinline 2 m, weiß lackiert
Twinline 2 m, white painted



801103* Twinline 2 m, schwarz lackiert
Twinline 2 m, black painted



801106 Satz Endkappen grau, mit Loch
Set of end caps grey, with hole



801107 Satz Endkappen grau, ohne Loch
Set of end caps grey, without hole



801108 Satz Endkappen silber, mit Loch
Set of end caps silver, with hole



801109 Satz Endkappen silber, ohne Loch
Set of end caps silver, without hole



801110 Satz Endkappen schwarz, mit Loch
Set of end caps black, with hole



801111 Satz Endkappen schwarz, ohne Loch
Set of end caps black, without hole



801112 Satz Endkappen weiß, mit Loch
Set of end caps white, with hole



801113 Satz Endkappen weiß, ohne Loch
Set of end caps white, without hole

*Profile in silber eloxiert sind lagernd, alle anderen Farben auf Anfrage

*Profiles in silver anodized are on stock, all other colours are on demand

LED-Profil Serie Horizon

LED profile series Horizon

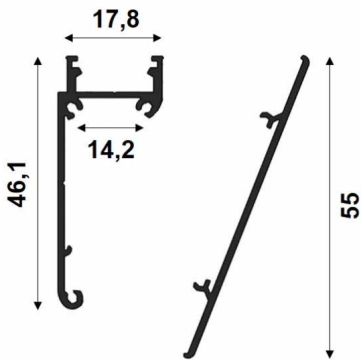

*Profile in silber eloxiert sind lagernd, alle anderen Farben auf Anfrage

*Profiles in silver anodized are on stock, all other colours are on demand



801030 Horizon 2 m, silber eloxiert
Horizon 2 m, silver, anodized



801032* Horizon 2 m, weiß lackiert
Horizon 2 m, white painted



801038 Satz Endkappen silber, flach
Set of end caps white, flat



801039 Satz Endkappen silber, halbrund
Set of end caps silver, half round



801042 Satz Endkappen weiß, flach
Set of end caps white, flat



801043 Satz Endkappen weiß, halbrund
Set of end caps white, half round



801045 Horizon Blende 2 m, silber eloxiert
Horizon cover 2 m, silver anodized



801047 Horizon Blende 2 m, weiß lackiert
Horizon cover 2 m, white painted



801305 Abdeckung 13 mm x 2 m, klar, rastend
Cover 13 mm x 2 m, clear, snap-in



801306 Abdeckung 13 mm x 2 m, opal, umgreifend
Cover 13 mm x 2 m, opal, clasping



801326 Abdeckung 13 mm x 2 m, rauch, rastend
Cover 13 mm x 2 m, smoke, snap-in



801025 Abdeckung 19,5 mm x 2 m, opal, umgreifend
Cover 19,5 mm x 2 m, opal, clasping



801311 Abdeckung 15 mm x 2 m, klar, einschiebbar
Cover 15 mm x 2 m, clear, slideable



801312 Abdeckung 15 mm x 2 m, matt, einschiebbar
Cover 15 mm x 2 m, frosted, slideable



801313 Abdeckung 15 mm x 2 m, opal, einschiebbar
Cover 15 mm x 2 m, opal, slideable



801049 Verbindungsplatte 22 x 24mm, glatt + Schraube
Connector plate 22 x 24 mm, flat + screw